



# OWNER'S MANUAL

## Wood Shredder Chipper





## **Contents**

### **General**

1. Limitations of use .....	4
2. Specification of use .....	4
3. Description of the Machine .....	4
4. Symbols.....	6

### **Working with the**

1. Safety and technical remarks .....	7
2. Before operating the machine .....	10
3. Starting and operating the machine .....	10
4. Transportation .....	12

Maintenance and checks.....	12
-----------------------------	----

Problems and solutions .....	13
------------------------------	----

Technical specifications.....	14
-------------------------------	----

Spare parts drawing .....	15
---------------------------	----

Spare parts list.....	16
-----------------------	----

## GENERAL

### . Intended use

The shredder is designed solely for shredding/chipping all kinds of newly cut tree branches of diameter up to 8.5 cm.

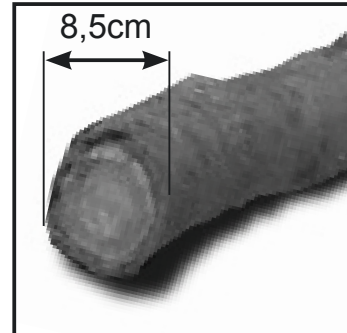

### . Restrictions

You should not use the shredder for shredding/chipping metal, stones, plastics. If you are going to shred tree roots check that the diameter is less than 8.5 cm and remove all earth, sand and stones.

Before using the machine for the first time, check the maximum engine speed by screwing in/out the screw which controls the position of the throttle lever so that it is positioned as in the diagram. (*fig. 3*) After the first hour's use check that the bolts of the blades and counter blade are firmly fixed and that the gap between blades and counter blade is 0.5mm (half a millimetre). Adjust in the slots if necessary and fix the bolts.(*fig. 2a, 2b*)

### . Description of the Machine

The shredder is a machine for shredding/chipping newly cut wood. The rotor has 2 blades each with a 30 cm width and is powered by a gasoline engine. Transmission is through two parallel drive belts. The shredded wood or chips are discharged through the output tube by the centrifugal force of the rotor. Because of the angle of the blades and the positioning of the counter blade branches are pulled inside the machine automatically and no feeder belt is required. (*fig. 1*)

**Fig. 1**



## 5. Symbols

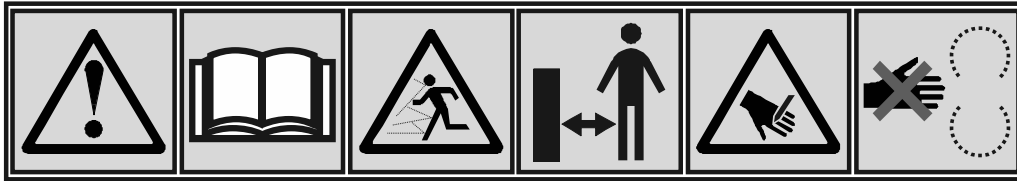

N.B.: Before use, make sure that the manual has been carefully read. Become familiar with the controls so as to use the machine correctly. Obey all safety instructions!

# WORKING WITH THE SHREDDER

## 1. Safety and technical remarks

- 1.1. The user should be 18 years old or more.
- 1.2. The machine should be positioned on a horizontal, firm surface.
- 1.3. Users must wear safety gloves, ear-protection and safety goggles. (fig. 4)
- 1.4. When working in a confined space, always make sure there is sufficient ventilation and lighting, in order to reduce the risk of suffocation and injury.
- 1.5. Only one person at a time should operate the machine.



- 1.6. Pieces jamming the input tube can only be removed safely when the engine is stopped, the spark plug cap removed and the rotor is stopped and blocked. If necessary, unbolt and tip the input and output tubes to facilitate access to the rotor. Use a wooden pole to remove pieces stuck in the rotor. Never use your hands. (*fig. 6 - 8*)
- 1.7. Never leave the machine running unattended.
- 1.8. Changing the blades of the rotor or the counter blade and checking blade bolts should only be done when the engine and rotor are stopped, the spark plug cap is removed and the rotor is blocked.
- 1.9. After one hour of use always check that all bolts and nuts are still tightened properly. If not, tighten them again or bring the machine back to your dealer/service-point.
- 1.10. Use only original parts for maintaining your shredder, otherwise the warranty will be void.
- 1.11. The shredder can only be repaired by a skilled dealer/service-point.
- 1.12. The shredder exceeds 90 dBA during operation. Therefore all users and onlookers must wear ear-protection.
- 1.13. Before use, make sure that the bolts on the fixed blade are firmly fixed. Check after one hour that the bolts still are firmly fixed (just first time).



fig. 5

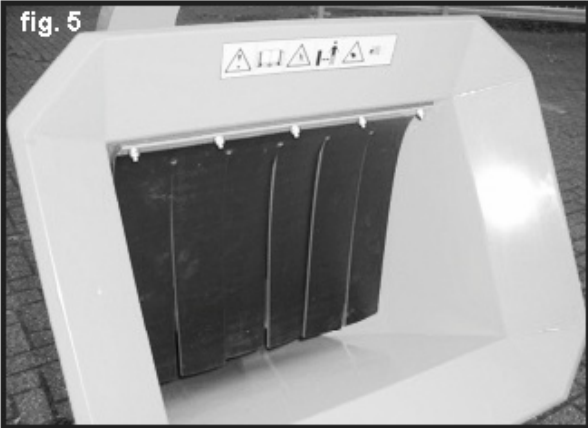

fig. 6



fig. 7

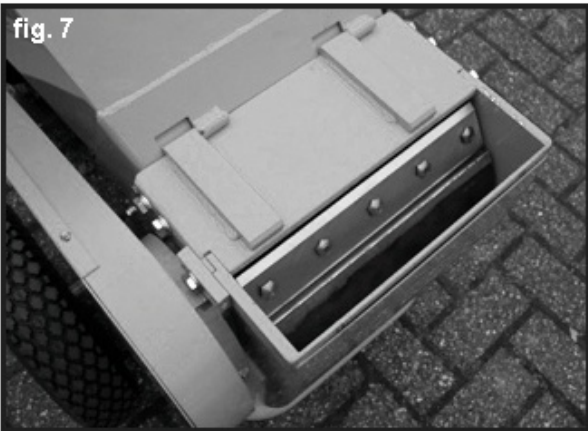

fig. 8



## 2. Before operating the machine

Make sure the machine stands firmly on the ground and does not tilt in any way. The danger zone on the output of the machine must be respected, in order to avoid serious injury by chips thrown out of the output tube. Chips can be thrown a distance of 12 meters, so onlookers must remain behind the direction of throw or at least 12 meters away from the output tube.

Before using the machine for the first time, check the maximum engine speed by screwing in/out the screw which controls the position of the throttle lever so that it is positioned as in the diagram.

After the first hour's use check that the bolts of the blades and counter blade are firmly fixed and that the gap between blades and counter blade is 0.5mm (half a millimetre). Adjust in the slots if necessary and fix the bolts.

## 3. Starting and operating the machine

Start the engine at half throttle and let it warm up for about 3 minutes. (For proper use of the engine one should also read the attached manual). Then put the engine on full throttle. (*fig. 9, 10*)

Put the branches in the input tube and when you feel they are pulled in by the rotating blades, let the branch go. Do not hang on to the branch, the branch will be pulled in by the machine by itself. Side branches with a diameter exceeding 3 cm should be sawn or cut off and shredded separately.

### **Warning!**

In case of emergency or any doubt, immediately activate the safety switch (red knob) to be found by the engine. (*fig. 11*)

Before starting the engine check that the bolts holding the input and output tubes are fully tightened. (*fig. 12, 13*)

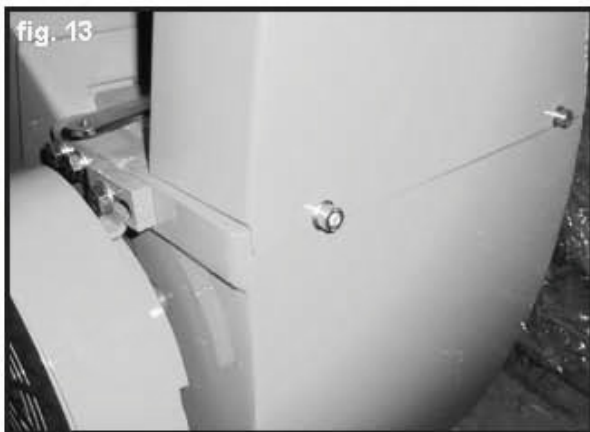
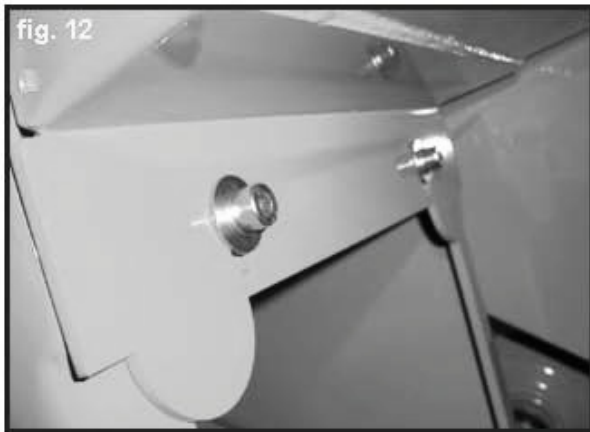
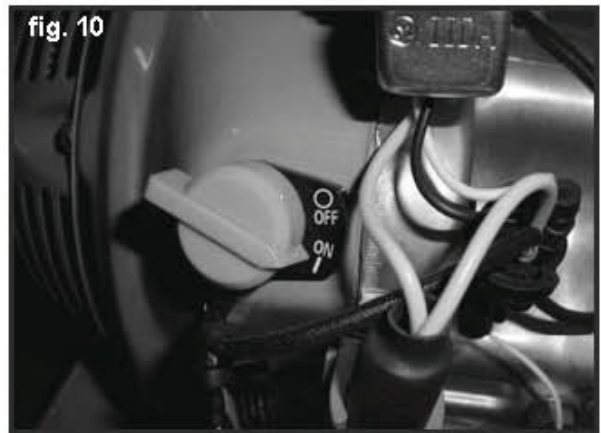
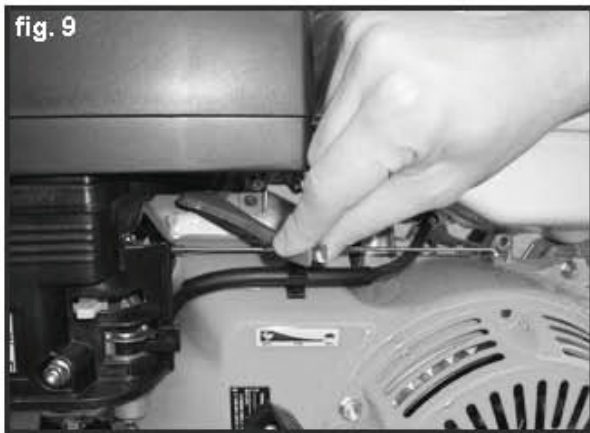

## 4. Transport

Before moving the machine, stop the engine!

### **MAINTENANCE AND CHECKS**

All technical check-ups and maintenance should be done with the engine shut off and the spark plug cap removed from the spark plug.

While cleaning the shredder, never spray the bearings with a high pressure washer! It could cause water to enter the bearings which will cause damage to the machine; (this is not covered by warranty).

The two grease nipples on the rotor require lubricating once a year or every 500 hours.

Before putting the shredder into storage grease or oil the bearings, blades and rotor to protect against corrosion.

1. Points to be checked
2. Cleaning the machine

For engine maintenance refer to the Engine Manufacturers Engine Manual.

Note that the first engine oil change is after 5 hours use.

## PROBLEMS & SOLUTIONS

Problem	Cause	Solution
The shredder does not perform properly: the wood is not pulled in by the machine itself. The chips do not have the same size.	<ul style="list-style-type: none"> <li>-The blades are worn too much</li> <li>-The diameter of the branches inserted into the machine is too large</li> <li>-There is too big a gap between the fixed blade and the counter blade: correct gap is 0.5 mm (half a millimetre)</li> </ul>	<ul style="list-style-type: none"> <li>-Change or sharpen the blades and counter-blade. Note that the blades are sharpened on both edges so they can be reversed.</li> <li>-Shut the engine off and remove the branch that is too thick</li> <li>-Adjust the gap between the blade and the counter-blade by moving the counter-blade in the slots</li> </ul>
The engine does not start/ the engine shuts off by itself	<ul style="list-style-type: none"> <li>-Electrical problem with the engine</li> <li>-No fuel</li> <li>-No or not enough oil in the engine (the oil should be level with the threads of the fillr hole.)</li> </ul>	<p>Check that</p> <ul style="list-style-type: none"> <li>-The input tube is correctly fitted and the bolts are tight</li> <li>-Put the start-switch of the engine "On"</li> <li>-De-activate the emergency switch (turn the knob)</li> <li>-Check oil and fuel levels</li> <li>-Contact your dealer</li> </ul> <p>Important : Screw back the blade bolts.</p>
The rotor jams The engine will not start/turn because the rotor is jammed.	<ul style="list-style-type: none"> <li>-the diameter of the branch is too big</li> <li>-there are unacceptable materials such as stones or metal in the input tube</li> <li>-a length of branch remains in the rotor after the engine was last stopped.</li> </ul>	<ul style="list-style-type: none"> <li>-shut off the engine, remove the spark plug cap and turn the rotor counter-clock-wise. Use a wooden stick to turn the rotor and to remove the material from the rotor and input tube.</li> <li>If necessary, remove the cap of the bearing housing and rotate the rotor axle with a spanner.</li> <li>If necessary, remove the input or output tube to facilitate access to the rotor.</li> <li>Check the sharpness of the blades and counter blade and replace them if necessary.</li> <li>Important: Screw back the blade bolts.</li> </ul>

## **TECHNICAL SPECIFICATIONS**

Engine: 4 stroke

Maximum rpm: 3600

Fuel: Lead free petrol

Shredding system: 2 blades on rotor and 1 counter-blade on the chassis. Blades are sharpened on both edges so they can be reversed. Gap between blades and counter-blade : 0.5mm (half a millimetre)

Transmission : twin V belts running in parallel

Dimensions:

- max. length: 150 cm
- max. height: 150 cm
- max. width: 80 cm
- weight: 160 kgs

All rights and modifications reserved



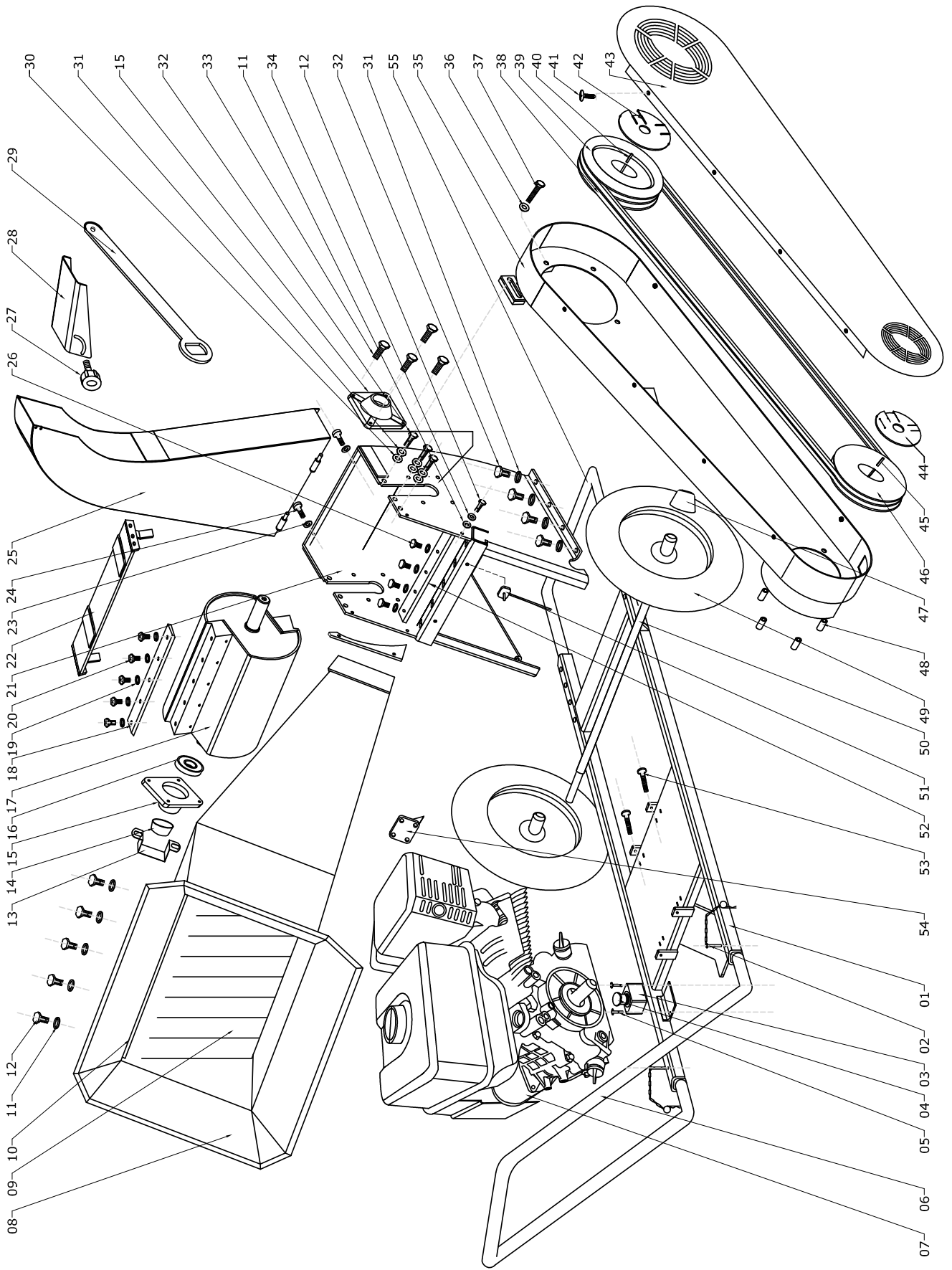



<b>DRAWING NR.</b>	<b>DESCRIPTION</b>	<b>QUANT.</b>
1	frame	1
2	pin	2
3	emergency switch box	1
4	emergency switch	1
5	bolt	2
6	handle	1
7	engine	1
8	hopper	1
9	rubber cover	1
10	strip 3mm	1
11	washer M6	6
12	bolt M6	6
13	lock washer	1
14	cap Bearing	1
15	bearing housing	2
16	bearing	2
17	rotor	1
18	blade	2
19	washer	5
20	special bolt for blade	5
21	shredder box	1
22	top of the box	1
23	washer	2
24	bolt	2
25	conveyer	1
26	bolt for counter blade	5
27	bolt special	1
28	deflector	1
29	rotor key	1
30	locking washer M8	6

<b>DRAWING NR.</b>	<b>DESCRIPTION</b>	<b>QUANT.</b>
31	washer	14
32	bolt	14
33	bolt for bearing housing	8
34	locking washer M6	2
35	belt cover	1
36	washer	8
37	bolt	8
38	V belt A1780 L4/13x1750L, A69	2
39	belt pulley 146	1
40	key for rotor	1
41	screw	4
42	safety ring for Rotor	1
43	belt cover - top	1
44	safety ring for engine	1
45	key	1
46	belt pulley	1
47	cap for wheel	1
48	spacer	4
49	wheel	2
50	axle	1
51	safety switch	1
52	counter blade	1
53	bolt	2
54	cover of the muffler	
55	bumper	1



