

# AMBAR 3V EcoDesign

# PANADERO

## MEASURES

DIMENSIONS H x W x D	810x563x430 mm
GROSS/NET WEIGHT	103/95 kg
FIREWOOD ENTRANCE	485x361 mm
SMOKE FLUE	Ø 150-153mm Top
DIAGONAL GLASS LENGTH	600 mm







## CHARACTERISTICS

CAST IRON GRILL AND DOOR	
THREE-SIDED VISION	
NOMINAL HEAT OUTPUT	7,1 KW
EFFICIENCY	77 %
CO EMISSIONS	0,10 %
HEAT RESISTANT PAINT	800°C
CERAMIC GLASS HEAT RESISTANCE	750°C

EAN 8426964186963  
REF. PANADERO 18696

## PRODUCT PLUS

### ECODESIGN 2022

-  VERMICULITE LINING
-  WOOD LOGS 50 CM
-  220 m<sup>3</sup> HEATING VOLUME
-  CLEAN GLASS SYSTEM
-  TRIPLE COMBUSTION
-  DOUBLE STEEL BODY SHEET 4 + 3 MM
-  WOOD LOG STORAGE

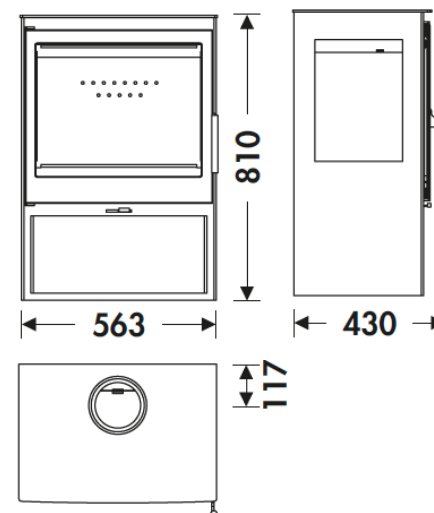

Art. 15a B-VG

B1mSchV2



AMBAR