

EN

LUBA mini 2 AWD Series

1000/1500/1500H

USER MANUAL

Original Instructions Version 1.0

05/2026



MAMMOTION



This manual is copyrighted by Mammotion company. Without the written permission of Mammotion, no company or individual shall copy, modify, reproduce, transcribe, or transmit this manual in any way or for any reason. This manual is subject to change without notice at any time.

Unless explicitly stated otherwise, this manual serves solely as a usage guide, and all statements and information contained herein do not constitute any form of warranty.

Intended Use

Mammotion robots are designed for residential lawn care and are not intended for commercial use.

NOTE



This manual applies to LUBA mini 2 AWD Series 1000/1500/1500H and all functions are applicable to these models unless stated otherwise. Figures are for reference only, refer to the actual purchase for details.

Revision Log

Date	Version	Description
05/2026	v1.0	Initial version

CONTENTS

1	Safety Instructions	- 1 -
1.1	General Safety Instructions	- 1 -
1.2	Charging Station Safety Instructions	- 2 -
1.3	Mowing Safety Instructions	- 2 -
1.4	Battery Safety Instructions	- 3 -
2	Instructions	- 4 -
2.1	Product Overview	- 4 -
2.2	LED Indicator Codes	- 8 -
2.3	Product Symbols	- 9 -
3	Getting Started	- 11 -
3.1	Installing the Vision Module.....	- 11 -
3.2	Installing the Charging Station	- 11 -
3.3	Downloading Mammotion App	- 14 -
3.4	Setting Up Your Robot	- 15 -
3.5	Pre-Mowing Preparations.....	- 15 -
3.6	Mapping and Mowing Your Lawn.....	- 17 -
3.7	Recharging.....	- 17 -
4	Daily Mowing	- 18 -
4.1	DropMow.....	- 18 -
4.2	Regular Task (Custom Settings)	- 18 -
4.3	Scheduled Task	- 20 -
5	Mammotion App	- 21 -
5.1	Map Elements	- 21 -
5.2	Mowing Settings.....	- 23 -
5.3	Safety & Protection	- 24 -

5.4	Security & Tracking	- 24 -
5.5	Upload Logs	- 25 -
5.6	Update Firmware.....	- 25 -
6	Maintenance.....	- 26 -
6.1	Cleaning.....	- 27 -
6.2	Cutting Blades Maintenance	- 28 -
6.3	Battery Maintenance	- 29 -
6.4	Storage.....	- 29 -
7	Transportation and Moving	- 30 -
8	Disposal.....	- 31 -
9	Product Specifications.....	- 32 -
9.1	General Specifications	- 32 -
9.2	Operating Bands Specifications (For EU Models)	- 34 -
9.3	Battery Specifications.....	- 35 -
10	Warranty.....	- 36 -

1 Safety Instructions

IMPORTANT

READ CAREFULLY BEFORE USE

KEEP THIS GUIDE FOR FUTURE REFERENCE

1.1 General Safety Instructions

1. Read and understand all instructions carefully before using the robot.
2. Only use parts and accessories recommended by Mammotion with the robot.
3. Never allow children, persons with reduced physical, sensory or mental capabilities or lack of experience and knowledge, or people unfamiliar with these instructions to use the robot. Local restrictions may restrict the age of the operator.
4. DO NOT allow children to be in the vicinity or play with the robot while it is operating.
5. DO NOT use the robot in areas where people are unaware of its presence.
6. When manually controlling the robot via the Mammotion app, always walk—never run. Be cautious on slopes and maintain proper footing and balance.
7. Only individuals who are legally considered adults in their state of residence are recommended to use the robot.
8. DO NOT touch moving parts, such as the cutting disc, until all motion has completely stopped.
9. If operating the robot in public areas, place warning signs around the task area with the following text: "Warning! Automatic lawn mower! Keep away from the robot! Supervise children!"
10. DO NOT leave the robot operating unattended if there are pets, children or people in the vicinity.
11. Wear sturdy footwear and long trousers when operating the robot.
12. To prevent damage to the robot and accidents involving vehicles and individuals, do not set task areas or channels across public pathways.
13. DO NOT connect or touch a damaged cable until it is disconnected from the power outlet. If the cable becomes damaged during operation, disconnect the plug from the power outlet. A worn or damaged cable increases the risk of electrical shock and should be replaced by authorized service personnel.
14. Keep extension cords away from moving hazardous parts, such as cutting blades, to avoid damage to the cords and robot.

15. DO NOT modify the robot by yourself. Modifications could interfere with robot operations, result in serious injury and/or damage, or void the warranty. Use only Mammotion-approved parts and accessories.
16. If the robot makes an abnormal sound or signals an alarm, press the STOP button immediately.
17. Regularly check that all parts of the robot can function normally.

1.2 Charging Station Safety Instructions

1. DO NOT set up the charging station in areas where people may trip over it.
2. DO NOT set up the charging station in areas where there is a risk of standing water.
3. Only use the official charging station to charge the robot. Incorrect use may result in electric shock, overheating, or corrosive liquid leakage from the battery. In case of electrolyte leakage, flush with water or neutralizing agent and seek medical aid if the corrosive liquid comes into contact with your eyes.
4. Keep the charging station and accessories at least 60 cm (24 in) away from combustible materials. Malfunctions or overheating can pose a fire risk.
5. For USA/Canada users: If installing the power supply outdoors, use a covered Class A GFCI receptacle (RCD) with a weatherproof enclosure. There is a risk of electric shock if improperly installed.

1.3 Mowing Safety Instructions

1. Keep hands and feet away from the cutting blades. DO NOT reach under or touch the robot while it is powered on.
2. DO NOT lift or move the robot when it is turned on.
3. Remove stones, branches, tools, toys, or other objects from the lawn before operation to prevent blade damage.
4. DO NOT put objects on top of the robot and charging station.
5. DO NOT use the robot if the STOP button is not functioning.
6. Avoid collisions with people or animals. Stop the robot immediately if someone or something enters its path.
7. Always turn off the robot when it is not in use.
8. DO NOT use the robot simultaneously with pop-up sprinklers and avoid setting a channel where sprinklers are installed.
9. DO NOT operate the robot in standing water or during heavy rain.

1.4 Battery Safety Instructions

Lithium-ion batteries can explode or catch fire if mishandled. Avoid disassembly, short circuits, exposure to water, fire, or high temperatures. Handle with care and avoid all mechanical or electrical abuse. Store batteries out of direct sunlight.

- 1.** Only use the official charging station and power supply. Incompatible chargers may cause electric shock or overheating.
- 2.** DO NOT attempt to repair or modify the batteries. Repair attempts may result in serious injury due to explosion or electrical shock. If a leak develops, released electrolytes are corrosive and toxic.

2 Instructions

2.1 Product Overview

The illustrations are for reference only. Refer to the actual product for details.

Top View

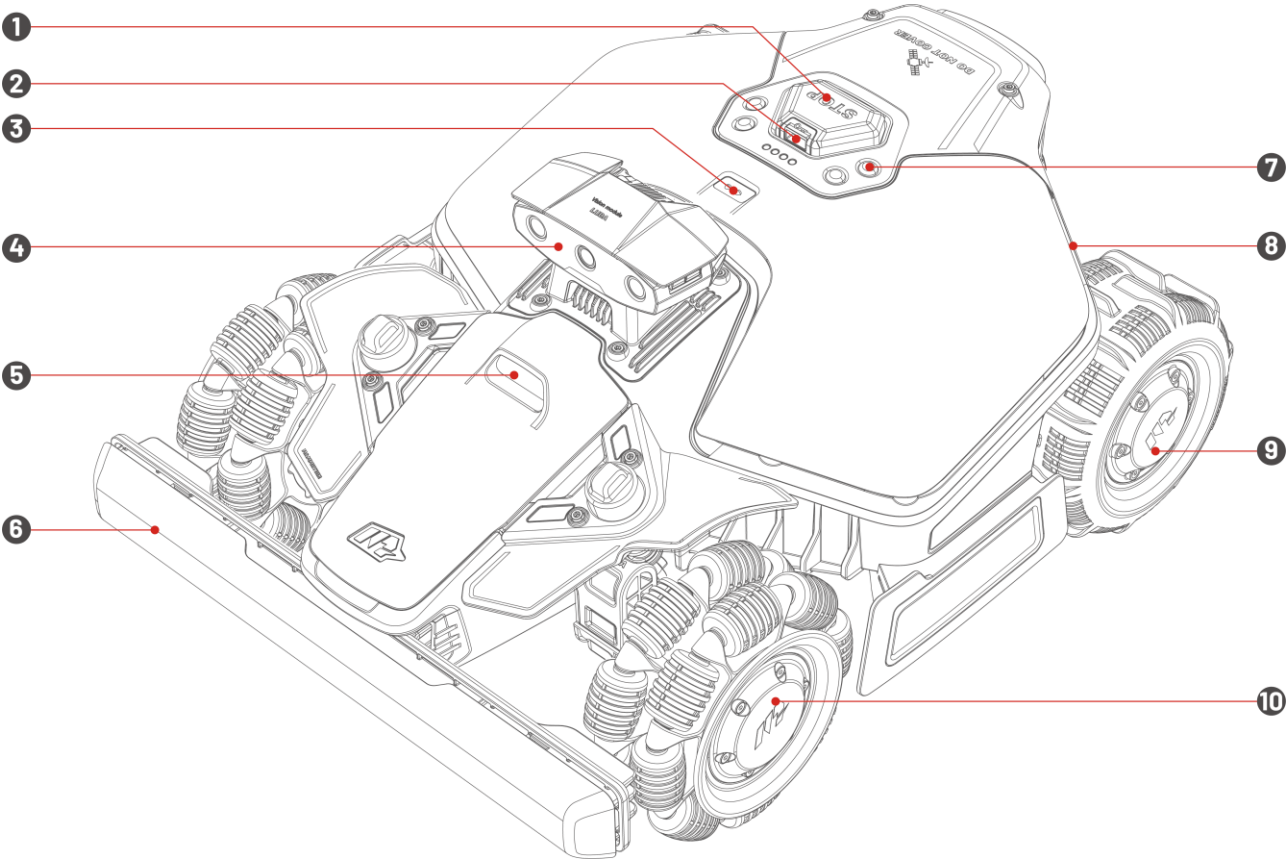

LUBA mini 2 AWD 1000

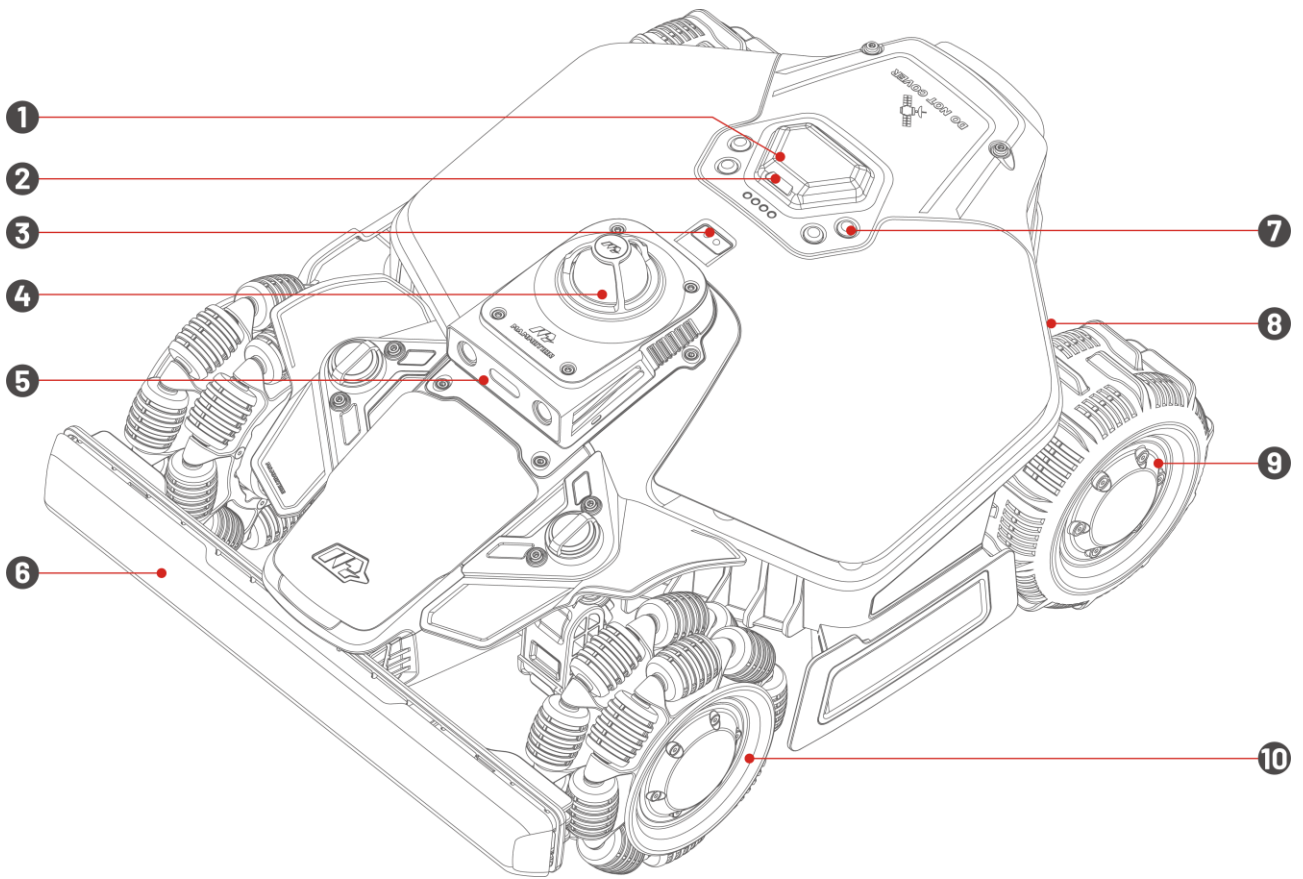







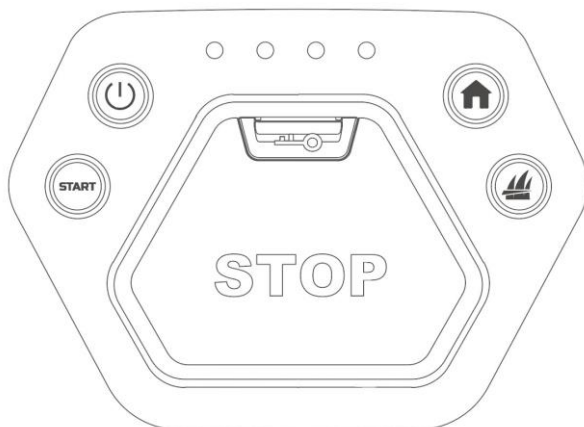



LUBA mini 2 AWD 1500/1500H

1. STOP Button
2. Security Key
3. Rain Sensor
4. Vision Module/LiDAR Module
5. Supplemental Light
6. Bumper
7. Controls
8. Side LED
9. Rear Wheel
10. Omni Wheel

Controls



Component	Description
	Long press to turn on/off the robot
	Double-press to unlock only the robot after an emergency stop
	Press to stop in an emergency
	Double-press to fully lower the cutting disc for cleaning
 > 	<ul style="list-style-type: none"> ● Press in sequence to continue working ● Press and hold  for 5 s, then press  to activate DropMow. See 4.1 DropMow for more information.
 > 	Press in sequence to send the robot to the charging station
	Indicate the battery level of the robot

Bottom View

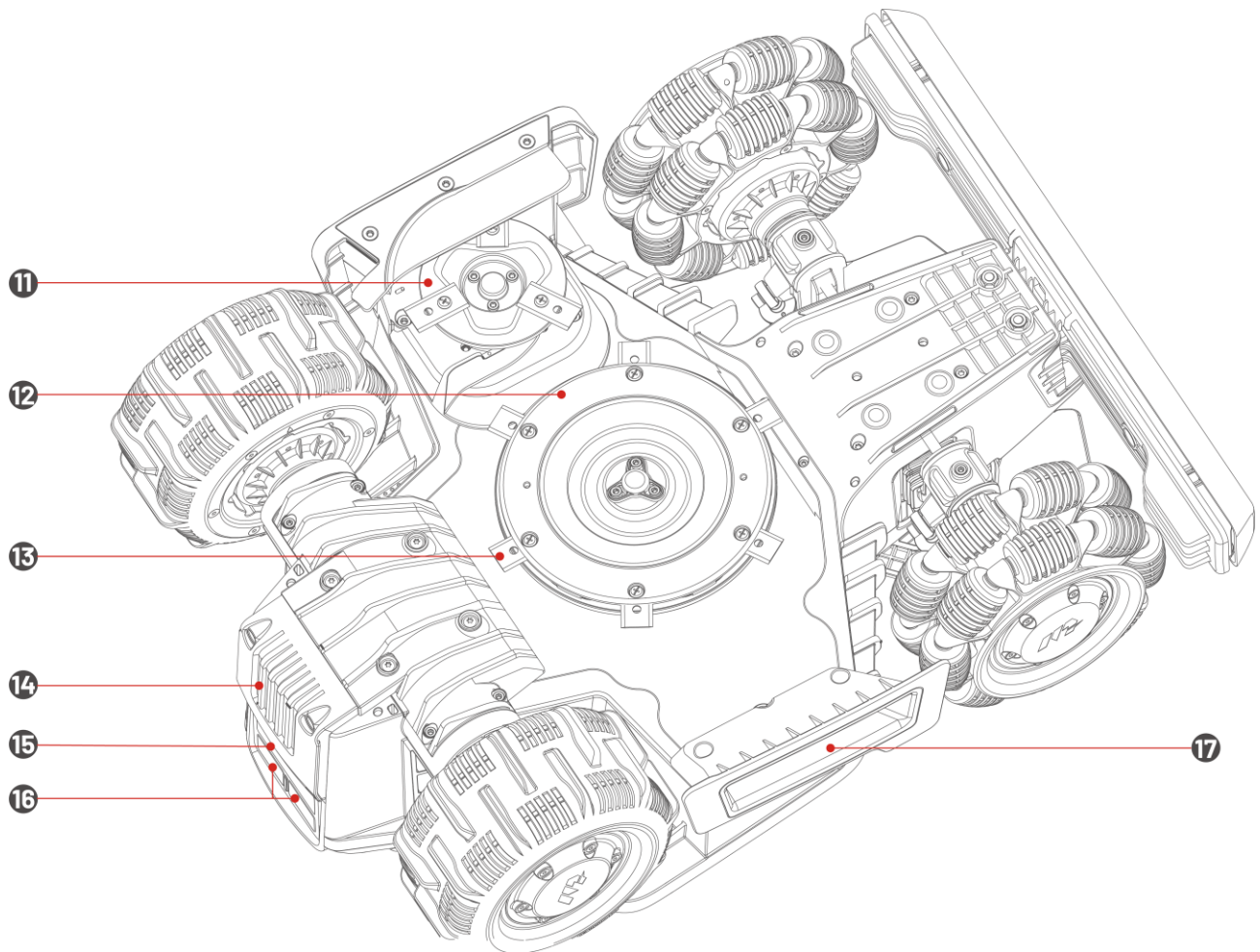

- 11. Edge Cutting Disc
- 12. Main Cutting Disc
- 13. Cutting Blade
- 14. Removable Battery
- 15. Infrared Receiver
- 16. Charging Pad
- 17. Handle

Charging Station

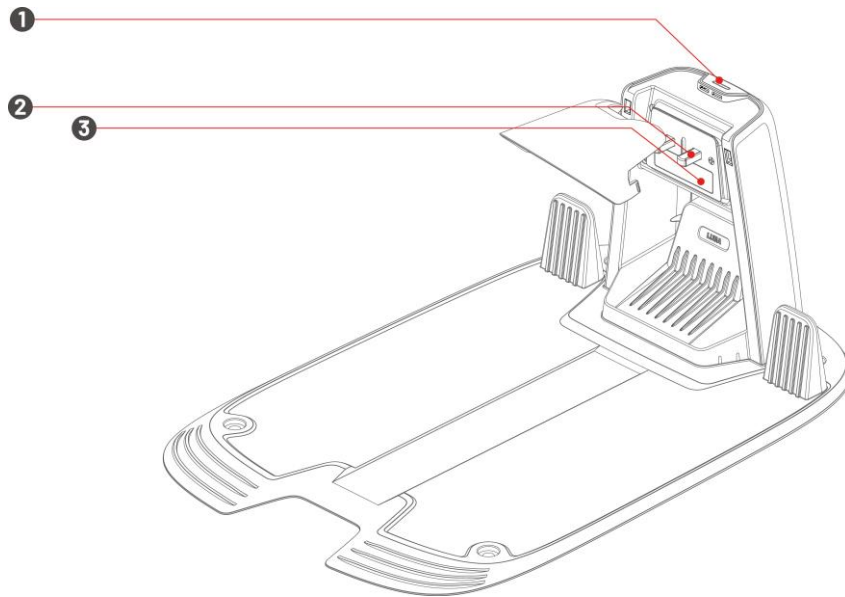

1. LED Indicator
2. Charging Contact
3. Infrared Transmitter

2.2 LED Indicator Codes

Robot

Indicator	Color	Description
Side LED	Solid red	<ul style="list-style-type: none"> ● The robot is functioning properly.
	Pulsing red	<ul style="list-style-type: none"> ● OTA update in progress. ● The robot is charging.
	Slow red blinking	<ul style="list-style-type: none"> ● STOP Button activated. ● Low battery. ● The robot is stuck. ● Security key not properly installed. ● The robot has been lifted, tilted, or flipped over.

	Fast red blinking	<ul style="list-style-type: none"> ● Robot malfunction. ● Robot update failed.
	Off	<ul style="list-style-type: none"> ● The robot is turned off. ● The robot is sleeping. ● The side LED is turned off in the app. ● The robot is in manual control mode but is currently inactive.











Charging Station

Indicator	Color	Description
LED	Blinking green	The robot is docked in the charging station.
	Solid green	The robot is not in the charging station.
	Solid red	Charging station malfunction.
	Off	No power.

2.3 Product Symbols

Please study these symbols found on the product and understand their meaning:

 TS-A081-2703002 ADS-81EJ-27-5	Use the detachable supply unit TS-A081-2703002/ADS-81EJ-27-5.
	This product complies with the applicable EU Directives.
Made in China	This product is manufactured in China.
	It is not permitted to dispose of this product as normal household waste. Ensure that the product is recycled in accordance with local legal requirements.
	This product can be recycled.

	<p>Keep this product's packaging dry.</p>
	<p>DO NOT cover this product's packaging.</p>
	<p>DO NOT flip this product's packaging.</p>
	<p>This product is fragile.</p>
	<p>DO NOT step on this product or its packaging.</p>
	<p>Class III appliance.</p>
<p> Do not touch rotating blade. Ne touchez pas la lame rotative.</p>	<p>WARNING — Do not touch rotating blade.</p>
	<p>WARNING — Read user instructions before operating the machine.</p>
	<p>WARNING — Keep a safe distance from the machine when operating.</p>
	<p>WARNING — Remove the disabling device before working on or lifting the machine.</p>
	<p>WARNING — Do not ride on the machine.</p>

3 Getting Started

3.1 Installing the Vision Module (LUBA mini 2 AWD 1000 only)

1. Detach the cover.
2. Attach the vision module by connecting the corresponding cables.
3. Tighten the screws.
4. Peel the sticker off the vision module.

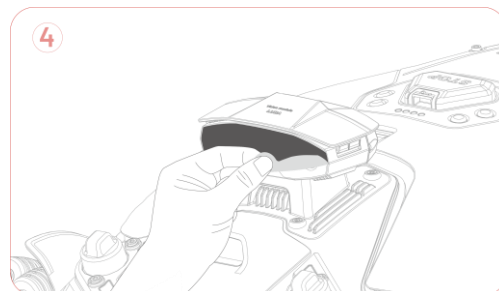
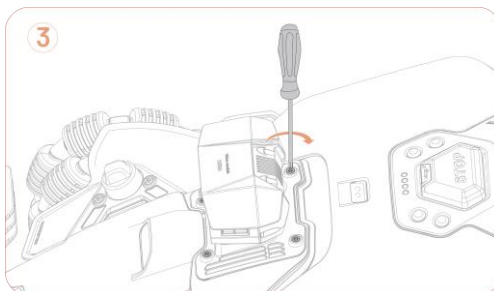
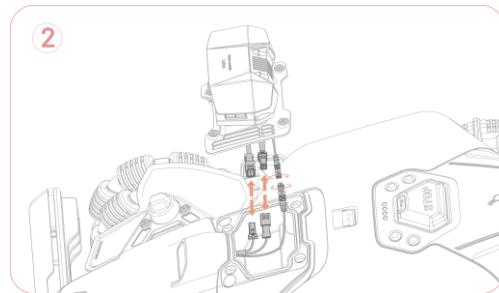
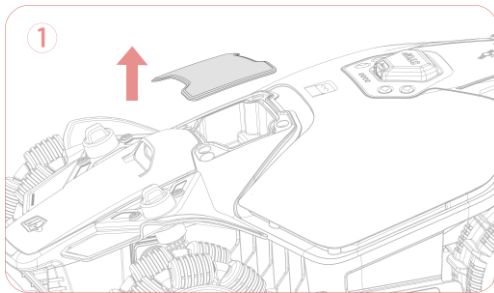

3.2 Installing the Charging Station

Choosing a Location for Charging Station

The charging station is where your robot docks and recharges. To ensure smooth operation, ensure the installation area meets the following conditions:

- **Flat surface:** The area should be free from significant bumps, slopes, or rocks.
- **Nearby power source:** An accessible power outlet is required for powering the charging station.
- **Clear surroundings:** There should be no obstacles (like trees or houses) within 1.5 m

(4.9 ft) to the left, right, and front of the charging station.

- **Well-lit:** Good lighting helps the robot navigate.
- **Close to the lawn perimeter:** Install the charging station close to the lawn perimeter for accurate positioning. If you have more than one lawn, it is recommended to place the charging station between them for optimal performance.

Assembling Charging Station

1. Attach the rain shade.

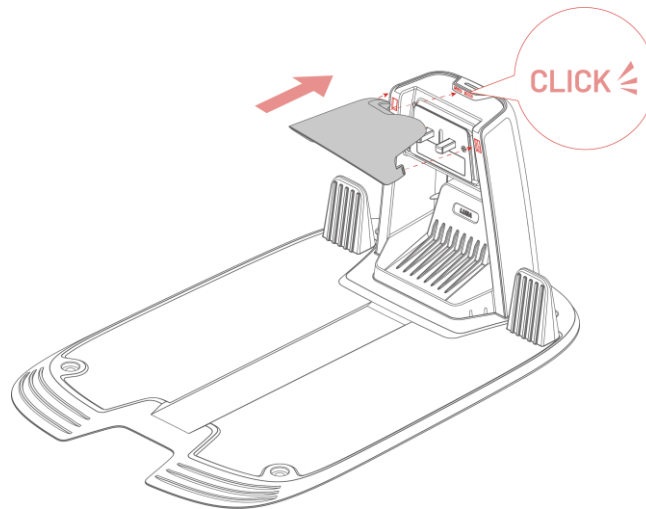

2. Use the included four stakes to secure the charging station to the chosen location. Make sure the charging station is facing the lawn.

NOTE



If the charging station is installed on a concrete surface, please secure it with expansion bolts (not included).

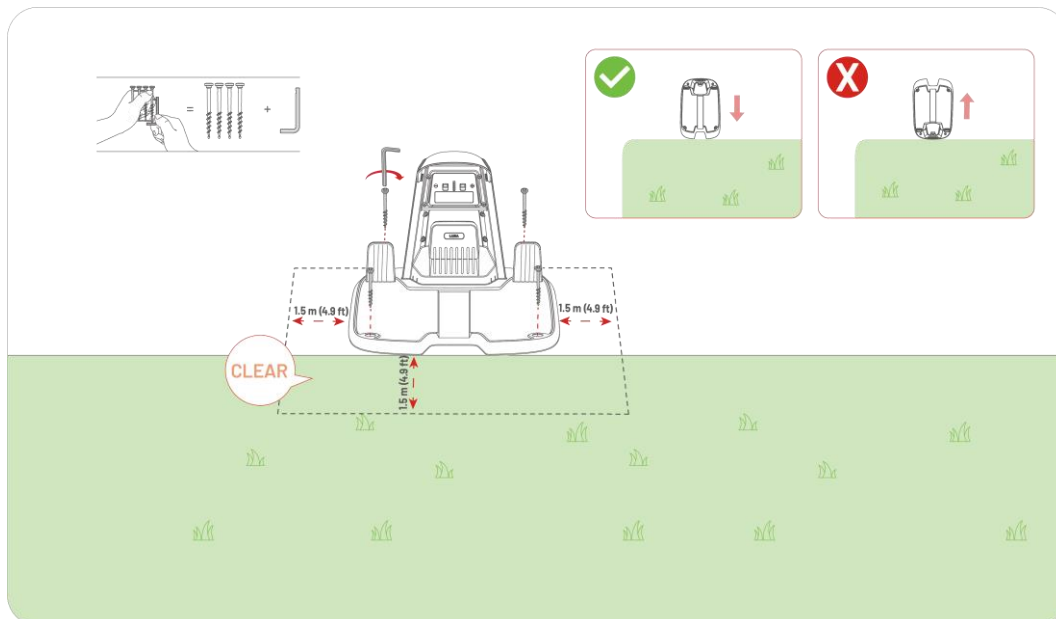

3. Connect the charging station cable to the charging station power supply.
4. Plug the charging station power supply into the power outlet. Secure the cable with the included cable pegs.
5. Dock the robot onto the charging station to begin charging. The side LED will turn red when the robot is properly docked.

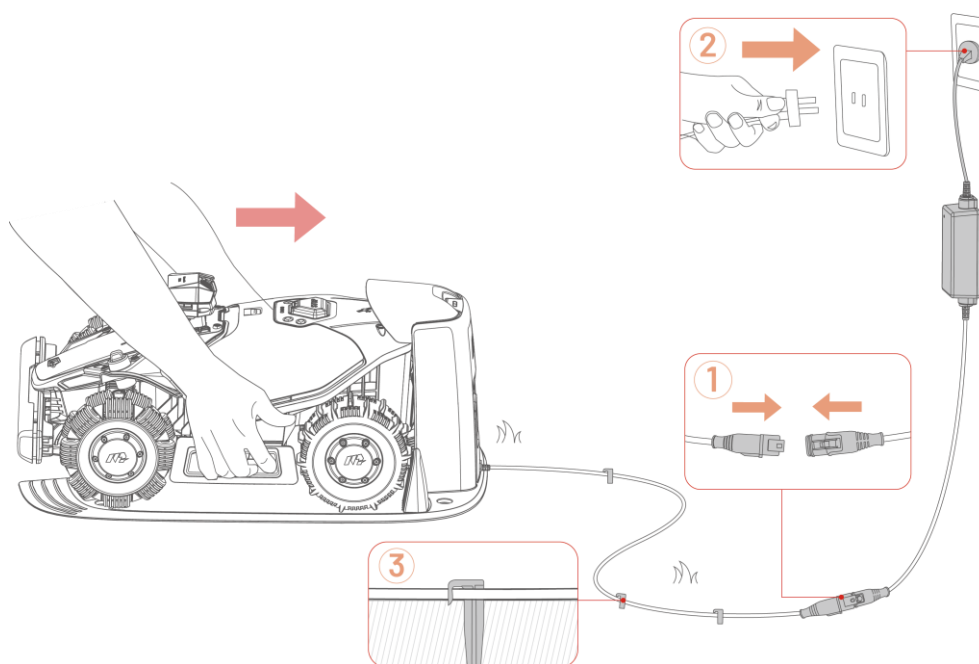

NOTE



Charge the robot for initial use to activate it.

3.3 Downloading Mammotion App

Scan the QR code below to download it from Google Play or the App Store, or search "Mammotion" on either store.





After installing the app, please sign up and log in. During use, the app may ask you for Bluetooth, Location, and local network access when necessary. For optimal performance, it is recommended to allow the above permissions. For more information, please refer to our Privacy Agreement (In the app, go to **Me > About Mammotion > Privacy Agreement**).

If you want to log in with a third-party account, tap  or  on the login page to continue.

Trademark Notice



The “” icon is the trademark of Google LLC. The “” icon is the trademark of Apple Inc. All trademarks mentioned in this manual are the property of their respective owners.

3.4 Setting Up Your Robot

NOTE



- Maintain a distance of 3 m (10 ft) or less between your phone and the robot.
- If you're using 4G mobile data, you can skip the Wi-Fi setup, but connecting to Wi-Fi is recommended for optimal performance.

1. Tap + to add your robot.
2. Follow the onscreen instructions to link your robot and connect to your Wi-Fi.

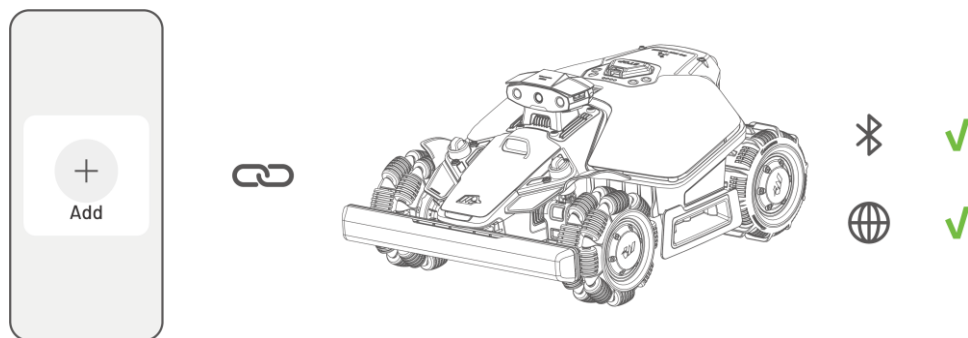

The built-in SIM card activates automatically during the robot linking process. If auto-activation fails, manually activate it by tapping Status Bar > **4G Status** > **Activate**.

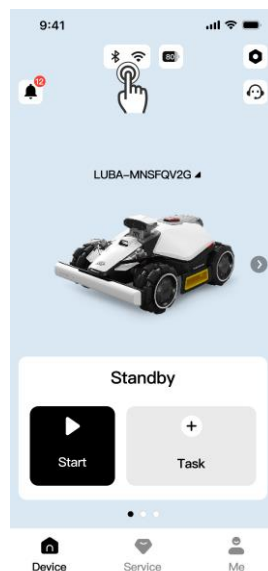

3.5 Pre-Mowing Preparations

- Remove debris, piles of leaves, toys, wires, stones, and other objects from the lawn.
- Make sure no children or animals are on the lawn.

- Ensure the robot is properly docked on the charging station and that the side LED is red.

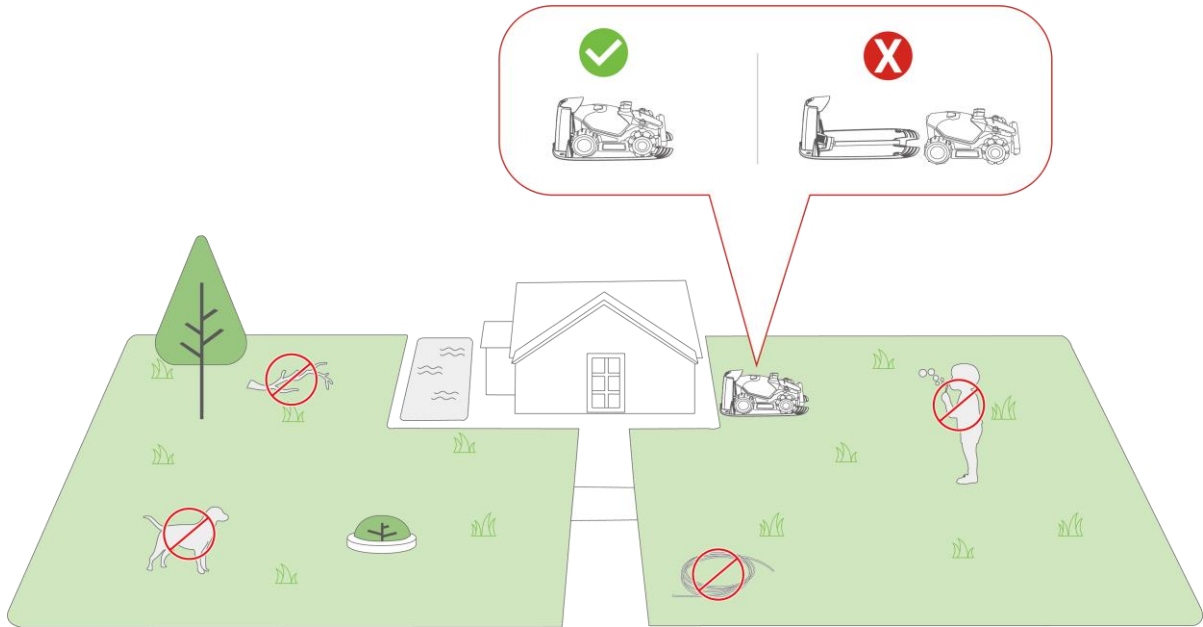

- For the best mowing results, it is recommended to mow in dry weather. Mowing in the rain can make the grass stick on the robot and cause slipping. DO NOT mow in bad weather, such as heavy rain, thunderstorms or snow.

3.6 Mapping and Mowing Your Lawn

1. Tap **Create Task Area** on the Home page.
2. Read and follow the in-app instructions to verify your robot is ready to map.
3. Tap **Start Mapping** to start map your lawn.
4. Tap **Mow** to start mowing after completing mapping.

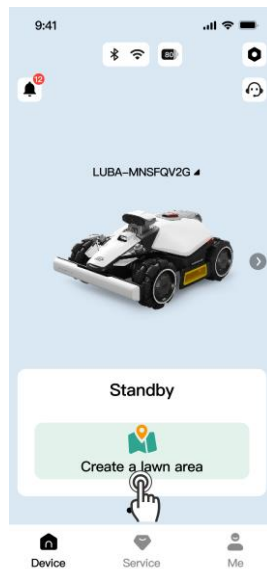

3.7 Recharging





NOTE

The robot must be in a task area to go to recharge.

To Recharge

- Tap  on the Map page in the Mammotion app.

OR

- Press the button  on the robot, then press  to send the robot to the charging station.

4 Daily Mowing

4.1 DropMow

DropMow is used for one-off mowing of unmapped lawns or for touch-up mowing outside of mapped areas.

Recommended uses include:



- Enclosed, even lawns with clear boundaries.
- Mowing areas that the robot cannot normally reach.
- Temporary mowing tasks that don't require a full map.

WARNING



- DO NOT use DropMow in lawns with unclear perimeters, or areas near steps, drop-offs, ponds, ditches, or pools, or in low-visibility environments, otherwise it may result in damage or injury.
- Ensure you have read and understood all instructions and warnings in the App before using DropMow.

To Use DropMow:

- Tap  > **Beta Features** > **DropMow** through the app. **OR**
- Press and hold  for 5 s, then press  on the robot.

4.2 Regular Task (Custom Settings)

To Customize your Mowing Task:

1. Tap the robot image to access the Map page.
2. Tap **Mow**  to access the task page.
3. Tap **Task Area** to select the area that you want to mow.
4. Tap **Settings** to configure task settings.
5. Tap **Start** to begin mowing.

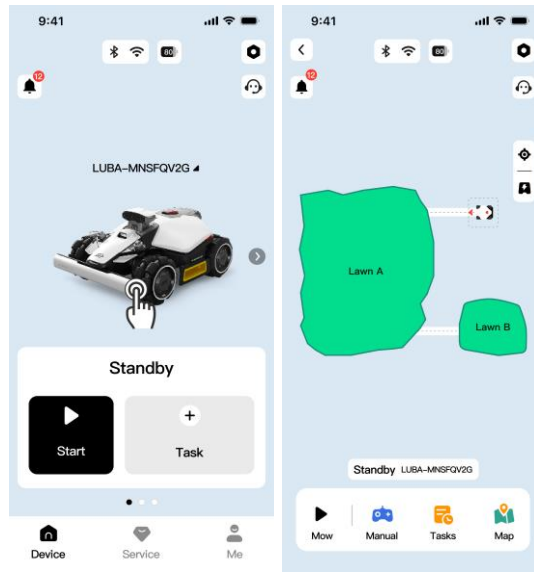

4.3 Scheduled Task

NOTE



- Scheduled tasks cannot be created while the robot is working.
 - Scheduled tasks can be set after a task area has been created.
-

To Schedule an Automatic Mowing Task:

1. On the Home page, tap **+** if no task has been created yet.
2. Tap **Task Area** to select the area to mow.
3. Tap **Settings** to configure parameters.
4. Tap **Schedule** to set the date and time, then tap **Save**.
5. Finally, tap **Save** again to confirm and save your scheduled task.

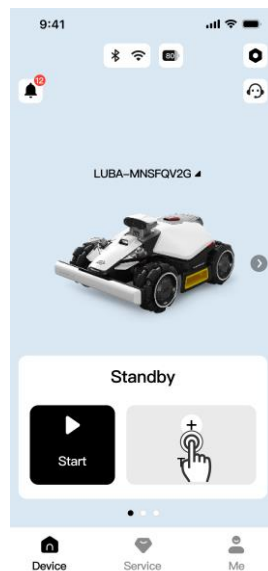

5 Mammotion App

With the Mammotion app, you can fully customize, manage, and monitor your robot, allowing you to control your mowing experience from anywhere.

5.1 Map Elements

Virtual Fence

A virtual fence acts as an invisible barrier, defining perimeters or restricting access to areas that you don't want the robot to go.

Recommended uses include:

- Lawns with unclear or undefined perimeters.
- Water features like pools or ponds.



No-go Zone

A no-go zone is an area you want your robot to completely avoid. They are crucial for protecting your robot from damage and keeping it away from sensitive or hazardous areas. The robot will not mow within no-go zones.

Recommended uses include:

- Low flowerbeds, especially those lower than 20 cm (7.8 in).
- Water edges, such as ponds or swimming pools, especially where there is no clear boundary.
- Transparent objects, such as mosquito nets or glass doors.
- Small or low-lying obstacles, e.g., clotheslines, tent ropes, or water pipes.
- Pet houses.

- High-value or delicate plants, including crops and ornamental plants.
- Irrigation equipment, such as hoses and sprinklers.



Obstacle-Free Zone

An obstacle-free zone is an area where the robot turns off its obstacle avoidance and does not stop for any obstacles while going to a task area or other location, and when going to recharge. They are useful for complex, but safe areas where the robot may get stuck otherwise.

Recommended uses include:

- Lawn areas that may be mistakenly recognized as invalid due to seasonal changes.
- Areas with low, safe obstacles.



Adding a Virtual Fence / No-go Zone / Obstacle-Free Zone

1. Tap the robot image on the Home page to access the Map page.
2. Tap **Map**.
3. Tap **Create**.
4. Select **Virtual Fence / No-go Zone / Obstacle-Free Zone** and follow the in-app instructions to finish adding.

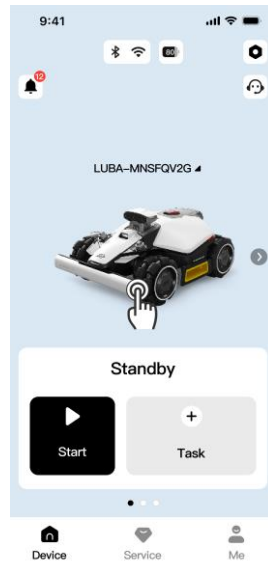

5.2 Mowing Settings

Cutting Path Mode

Select the optimal mode based on your lawn's condition and desired look under **Mow > Settings > Cutting Path Mode**.

- **Perimeter Laps Only:** Only mows the lawn edges.
- **Zigzag:** Creates classic striped lines.
- **Chess Board Path:** Mows in a crisscross pattern for a dense, even finish.
- **Adaptive Zigzag Path:** The robot automatically adjusts the path for efficiency.

Pattern

Add text or images to your map to personalize your lawn and express yourself. On the map, go to **Create > Pattern** to add a pattern.

5.3 Safety & Protection

Obstacle Detection

Adjust the robot's responsiveness to objects and varying terrain in its path. You can select one of three sensitivity levels under **Mow > Settings > Obstacle Detection Mode**:

- **Sensitive:** Increases the robot's sensitivity to both standard obstacles and non-grassy areas (e.g., pavement, gravel). Use this mode on complex lawns.
- **Standard:** Detects and avoids common obstacles (e.g., toys, furniture) encountered during mowing. This is the recommended default setting.
- **Off:** Disables obstacle detection. Use only in specific, controlled environments where detection is unnecessary or interferes with operation.

Rain Detection

Your robot is equipped with built-in rain sensors. When enabled, the robot will automatically stop mowing and return to the charging station when rain is detected.

- Enable this feature in **Settings > Rain Protection**.

Wildlife Safety

This feature helps protect nocturnal animals during nighttime operation. You can set the robot to perform **Low-Speed Mowing** or **Stop Mowing** entirely during night hours.

- Enable this feature in **Settings > Wildlife Safety**.

5.4 Security & Tracking

Geo-fence Alarm

The app will send you a push notification if the robot moves more than 50 m (164 ft) away from its designated task area, alerting you to potential unauthorized movement.

- To use, go to **Me > Find My Device** and enable **Location Notifications**.

GPS Theft Tracking

If your robot is missing, you can track its location in real-time via GPS, provided the robot was linked to the Mammotion app.

- To use, go to **Me > Find My Device** and enable **Location Recorder**.

5.5 Upload Logs

If you encounter any issues during use, you can upload the corresponding logs to help our technical support team diagnose and resolve the problem efficiently.

To Upload Logs

1. Tap  to enter the Settings page.
2. Tap **Upload Logs** and follow the in-app instructions to complete the upload.

OR:

Go to **Me > Upload Logs**, and follow the in-app instructions to complete the upload.

5.6 Update Firmware

For optimal experience, ensure your robot is updated to the latest firmware version.

To Update Firmware:

1. Go to  > **Device Information > Robot Version** to update the firmware.
2. Ensure the robot is connected to a stable network.
3. During the update, please avoid exiting the app, performing other operations or turning off the robot.

6 Maintenance

To maintain optimal mowing performance and extend the lifespan of your robot, Mammotion advises performing regular inspections and maintenance. For safety, always wear protective clothing such as trousers and work shoes; avoid wearing open sandals or going barefoot during maintenance.

- Before maintenance, turn off the robot and remove the security key.

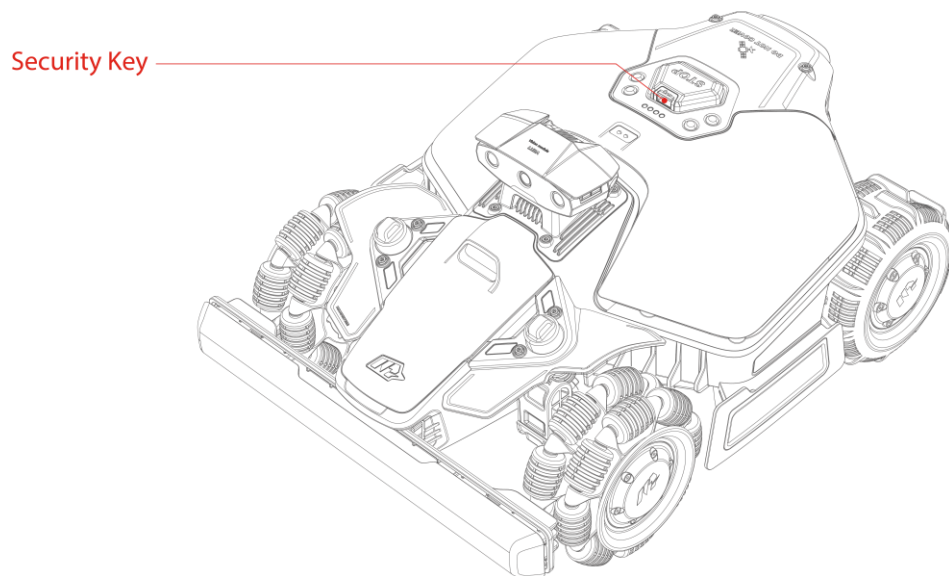

- DO NOT use a high-pressure washer or solvents to clean the robot.
- After washing, ensure that the robot is placed on the ground in its normal orientation, not upside down.
- DO NOT reverse the robot to wash the chassis. If you do reverse it for cleaning purposes, make sure to return it to its proper orientation afterward. This precaution is necessary to prevent water from leaking into the motor and potentially affecting normal operation.

6.1 Cleaning

Robot

WARNING



- Ensure the robot is completely powered off before beginning any cleaning work.
 - Always turn off the robot before turning it upside down.
 - When turning the robot upside down, handle it with care to avoid damaging the vision module/ LiDAR.
-

Housing

Use a soft brush or a damp cloth to clean the robot's housing. Avoid using alcohol, gasoline, acetone, or other corrosive or volatile solvents, as they may damage the robot's appearance and internal components.

Bottom

Wear protective gloves while cleaning the chassis and cutting disc. Use a brush to remove debris. Check for blade damage and ensure that the blades and cutting disc can rotate freely. DO NOT use sharp objects to clean the bottom.

Wheels

Clean the wheels using a brush or water hose. Remove the mud if any.

Vision Camera/LiDAR

Wipe the vision camera lens/LiDAR with a microfiber cloth to remove any stains.

Charging Station Cleaning

Unplug the charging station before cleaning or performing maintenance on the charging station. Use a brush and cloth to clean the infrared transmitter and the charging contact.

6.2 Cutting Blades Maintenance

WARNING



- Always wear protective gloves when replacing the blades. DO NOT use an electric screwdriver during installation.
- When replacing the blades, replace all the screws at the same time to ensure optimal cutting performance.
- After installing, ensure the cutting blades can all rotate freely.

- To ensure optimal performance during long-term storage, keep the hub motor shaft dry and clean. Regular maintenance of the motor shaft helps prevent dirt and moisture buildup, which can affect the motor's function.
- Cutting blades are considered wear parts and should be replaced if they become severely worn. It is recommended to replace the blades every 3 months or after 150 hours of use. For thicker grass, more frequent blade replacement may be necessary.

Replacing the Cutting Blades

1. Turn off the robot.
2. Place the robot on a soft, clean surface and turn it upside down. Take care to not put pressure on the vision module/LiDAR.
3. Remove the old cutting blades with the included screwdriver using the Phillips bit.
4. Install the new cutting blades using the included screws. Ensure that the blades can rotate freely and are securely installed.

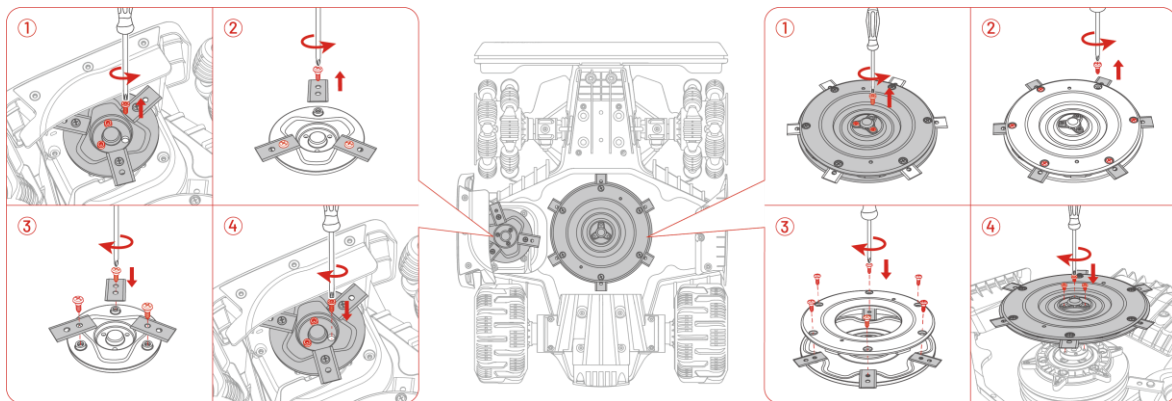

6.3 Battery Maintenance

- Charge the robot to at least 80% before long-term storage to prevent battery overdischarge.
- Recharge the robot to at least 80% every 90 days, even when it is not in use.
- Ensure the charging ports on the robot are clean and dry before storing or charging.

6.4 Storage

To ensure your robot is in optimal condition for the next mowing season, store the robot and charging station properly.

Storing the Robot

If the ambient temperature drops below -10 °C (14 °F) during winter, keep the robot indoors.

1. Control the robot off the charging station, ensuring the robot has been fully charged.
2. Turn off the robot.
3. Clean the robot with a damp cloth or soft brush. DO NOT turn the robot upside down to clean its chassis with water.
4. Leave the robot to dry. DO NOT turn it upside down during this process.
5. Apply anti-corrosion lubricant to the charging pads. DO NOT apply the chemicals to any other parts of the robot, especially metal contact areas, except for the connectors.
6. Store the robot indoors.

Store the Charging Station

If the ambient temperature drops below -20 °C (-4 °F) during winter, keep the charging station indoors.

1. Disconnect the power supply.
2. Remove the stakes.
3. Use a brush and cloth to clean the charging station thoroughly.
4. Store the charging station and the power supply indoors.

7 Transportation and Moving

For long-distance transportation, Mammotion recommends using the original packaging for both the robot and the charging station.

To Safely Move the Robot:

1. Turn off the robot.
2. Lift the robot using its handle.
3. Keep the cutting disc away from your body.

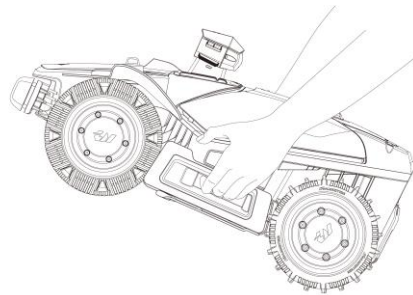
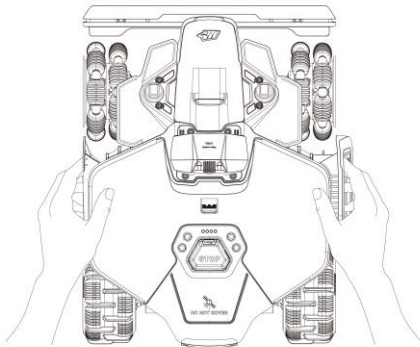

8 Disposal

When disposing of the product, please obey the local regulations and requirements.

Do not dispose of batteries with regular household waste. Remove the battery and return it to a collection point.

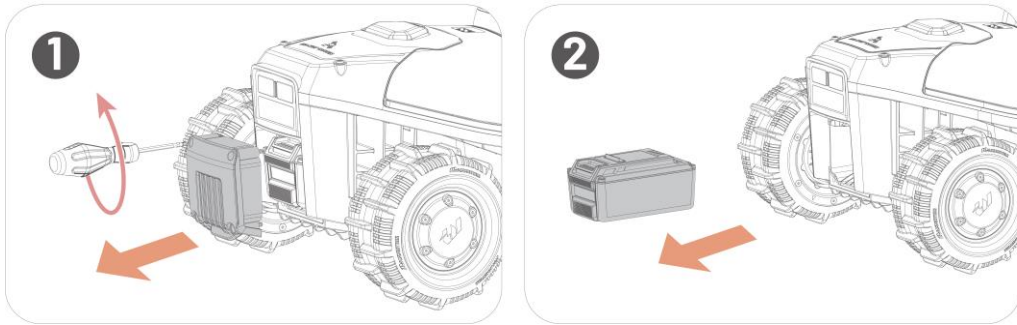

9 Product Specifications

9.1 General Specifications

Product Name	LUBA mini 2 AWD 1000/1500/1500H		
Model	LM2S2	LM2S1	LM2H1
Recommended Mowing Area	1,000 m ² (0.25 acre)	1,500 m ² (0.37 acre)	
Max. Multi-zone Management	10	20	
Engine	All-wheel-Drive (AWD)		
Max Slope inside Task Area	80% (38.6°)		
Max Slope at Edge	40% (21.8°)		
Vertical Obstacle Passing Ability	45 mm (1.8 in)		75 mm (2.9 in)
Cutting Width	Main Cutting Disc: 200 mm (7.8 in) Edge Cutting Disc: 120 mm (4.7 in)		
Cutting Disc	Main Cutting Disc: 1 Edge Cutting Disc: 1		
Cutting Height Adjustment	Main Cutting Disc: 20-65 mm (0.8-2.6 in) Edge Cutting Disc: 50 mm (2 in)	Main Cutting Disc: 55-100 mm (2.2-4 in) Edge Cutting Disc: 65 mm (2.6 in)	
Charging Time	150 min		
Mowing Time per Charge	150 min		
Auto-recharge	YES		
GPS Theft Tracking	YES		

Product Name	LUBA mini 2 AWD 1000/1500/1500H		
Geo-fence Alarm	YES		
Vision Geo-fence	YES		
Lift Sensor	YES		
Tilt Sensor	YES		
Positioning & Navigation	Triple-Camera AI Vision System	360° LiDAR & AI Vision	
Obstacle Avoidance	Triple-Camera AI Vision System & Physical Bumper	360° LiDAR Module & AI Vision & Physical Bumper	
Voice Control	Alexa & Google Home		
Vision Monitoring	YES		
Connectivity	4G & Bluetooth & Wi-Fi		
A-weighted sound power level	L _{WA} =64 dB, K _{WA} =3 dB		
A-weighted sound pressure level	L _{PA} =56 dB, K _{PA} =3 dB		
Waterproof	Robot & Charging Station: IPX6		
Rain Detection	YES		
OTA Upgrade	YES		
Recommended Operation Temperature	5-40 °C (41-104 °F)		
Recommended Store Temperature	-10-40 °C (14-104 °F)		
Net Weight	About 17 kg (37.5 lbs.)	About 17.2 kg (38 lbs.)	About 17.5 kg (39 lbs.)

Product Name	LUBA mini 2 AWD 1000/1500/1500H	
Dimensions (L x W x H)	584 x 460 x 290 mm (23 x 18 x 11.4 in)	584 x 460 x 320 mm (23 x 18 x 12.6 in)

9.2 Operating Bands Specifications (For EU Models)

Robot

Category	Frequency Range (MHz)	Maximum Transmitter Power (dBm)
LORA (LM2S2 only)	863.1-869.85	< 13.98
Bluetooth	2400-2483.5	< 20
Wi-Fi	2400-2483.5	< 20
	5550-5700	< 20
	5745-5825	< 13.98
LTE Band 1	Tx: 1920-1980 Rx: 2110-2170	25
LTE Band 3	Tx: 1710-1785 Rx: 1805-1880	25
LTE Band 7	Tx: 2500-2570 Rx: 2620-2690	25
LTE Band 8	Tx: 880-915 Rx: 925-960	25
LTE Band 20	Tx: 832-862 Rx: 791-821	25
LTE Band 28A	Tx: 703-736 Rx: 758-791	25
LTE Band 28B	Tx: 718-748 Rx: 773-803	25
LTE Band 38	Tx: 2570-2620 Rx: 2570-2620	25

LTE Band 40	Tx: 2300-2400 Rx: 2300-2400	25
GNSS	LM2S2: 1559-1610 1164-1215, 1215-1300 LM2S1/LM2H1: 1559-1610	N/A

9.3 Battery Specifications

Battery charger	Model: TS-A081-2703002/ADS-81EJ-27-5 Input: 100-240 V~, 50/60 Hz, Max. 2 A Output: 27 Vdc, 3 A, 81 W	
Battery	21.6 Vdc, 6.1 Ah, 131.76 Wh	
Battery Model	MWBT06S02P-01/MWBT06S02P-06	
Robot	Input: 27 Vdc, 3 A	
Charging Station	LM2S2/ LM2S1: Model: CHG4320 Input: 27 Vdc, 81 W Output: 27 Vdc, 3 A	LM2S1: Model: CHG4321 Input: 27 Vdc, 81 W Output: 27 Vdc, 3 A
Charging Temperature	4-45 °C (39-113 °F)	



WARNING

- Only use the power adapter provided with this product to recharge the battery.
-

10 Warranty

Shenzhen Mammotion Innovation Co., Ltd warrants that this product will be free from material and workmanship defects under normal use in accordance with the product materials published by Mammotion during the warranty period. The published product materials include but are not limited to the user manual, quick start guide, specifications, disclaimers, and in-app notifications. The warranty period varies for different products and parts. Refer to the table below for your product:

Component	Warranty
Battery	3 Years
Motor	
Vision Module/LiDAR Vision Module	
PCBA	
GPS Kit	
Charging Station	

If the product does not function as warranted during the warranty period, please contact Mammotion customer service for assistance.

- For products purchased from a local dealer, please reach out to the dealer first.
- Users must present a valid proof of purchase, receipt, or order number (for Mammotion Direct Sales). The Serial Number of the product is crucial for initiating warranty service.
- Mammotion will make every effort to address concerns through phone calls, email, or online chat.
- In some cases, Mammotion may advise you to download or install specific software updates.
- If issues persist, you may need to send the product to Mammotion or a local Mammotion-appointed service center for further assessment.
- The warranty period for the product begins from the original date of purchase indicated on the sales receipt or invoice.

- For pre-ordered products, the warranty period begins from the shipping date from the local warehouse.
- Mammotion requires users to arrange the shipment by themselves if they would like to send their product to a local service center or Mammotion for further assessment. Mammotion will repair and replace the product at no cost if the problem falls under the warranty. If not, Mammotion or designated service center may charge a fee accordingly.

Examples of Faults Not Covered Under Warranty:

- Failure to follow the instructions outlined in the user manual.
- If the product arrives damaged during shipment and is not rejected upon delivery, or if no official documentation confirming the damages is provided by the shipping company. Inability to provide evidence of damage occurring during transit.
- Product malfunction due to accidents, misuse, abuse, natural disasters like floods, fires, earthquakes, exposure to food or liquid spills, improper charging, or other external factors.
- Damage resulting from using the product in ways not permitted or intended as specified by Mammotion.
- Modification of the product or its components that significantly alters functionality or capabilities without obtaining written permission from Mammotion.
- Loss, damage, or unauthorized access to your data.
- Signs of tampering or alteration on product labels, serial numbers, etc.
- Failure to provide a valid proof of purchase from Mammotion, such as a receipt or invoice, or if there is evidence of forgery or document tampering.



SHENZHEN MAMMOTION INNOVATION CO., LTD

www.mammotion.com

Copyright © 2026, MAMMOTION All Rights Reserved.

If you have any feedback on the user manual, please feel free to contact us at: doc.support@agilex.ai